

LI-6400 System

Photosynthesis, Fluorescence, Respiration



LI-COR[®]
Biosciences



LI-6400... Superior By Design

For more than 30 years LI-COR® has maintained a world-wide reputation for making rugged, reliable, portable instrumentation for environmental research. The LI-6400 System is the embodiment of these qualities. But don't take our word for it – review the literature, talk to your peers who have used one, or talk to one of our knowledgeable Applications Scientists to see for yourself why the LI-6400 is the undisputed market leader.

LI-COR continues to develop integrated hardware and software solutions to help you perform your research better – things like new leaf chambers, a soil CO₂ flux chamber, software simulator and new AutoPrograms, faster processor, and an integrated leaf chamber fluorometer. No other system available provides this level of integration.

Whatever the demands, the LI-6400 can provide a solution to your research needs.



Photosynthesis, Fluorescence, Respiration

Performance

CO₂ and H₂O analyzers in the sensor head provide rapid response and eliminate time delays.

Integration

CO₂, light, temperature, and humidity are controlled manually or automatically.

Flexibility

Hardware and software may be easily adapted for a broad range of applications.

AutoPrograms

AutoPrograms control chamber conditions and logging parameters to automatically generate response curves and other data.

Support

World-wide training and service.



Innovative Technology

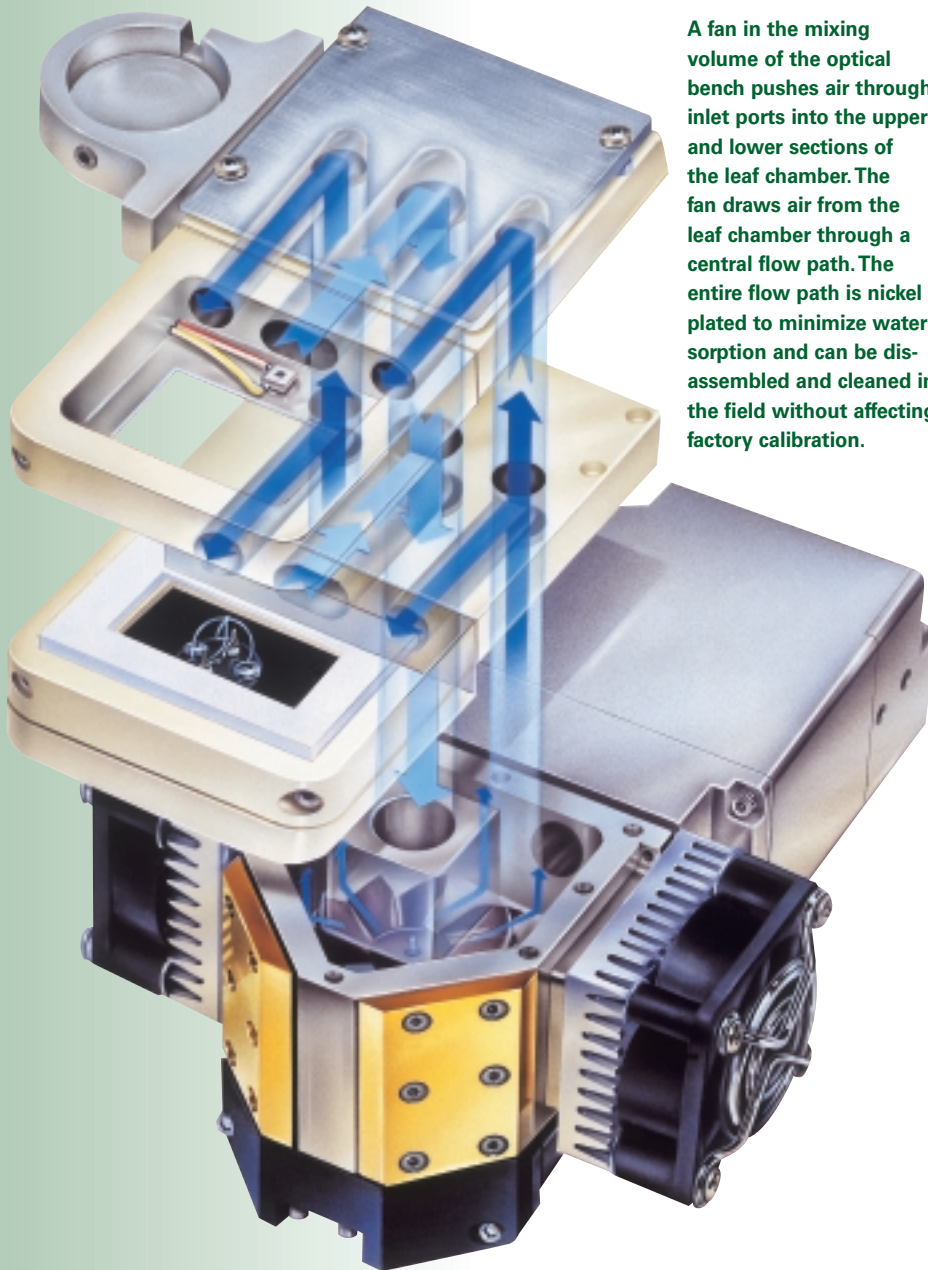

A fan in the mixing volume of the optical bench pushes air through inlet ports into the upper and lower sections of the leaf chamber. The fan draws air from the leaf chamber through a central flow path. The entire flow path is nickel plated to minimize water sorption and can be disassembled and cleaned in the field without affecting factory calibration.

CO₂/H₂O Analyzers in the Sensor Head

The LI-6400 is the first photosynthesis measurement system to put the gas analyzers in the sensor head – where they ought to be. These analyzers feature a novel,

open path design with the optical bench of the sample analyzer open directly to the leaf chamber mixing volume.

Leaf dynamics are measured in real time because the return tubing between the leaf

chamber and the console has been eliminated. There are no time delays to confound correlations between gas exchange and changes in environmental driving variables such as light, CO₂ mole fraction, etc.

The absence of time delays allows fast, automatic control of chamber humidity at user-defined set points, even when the transpiration rate is changing. The absence of return tubing to the analyzers also eliminates equilibration times due to water vapor sorption on the tubing walls.

The LI-6400 sensor head has two complete, dual path, non-dispersive infrared analyzers, which both measure absolute concentrations of CO₂ and H₂O.

Analyzer Operation

Infrared radiation from the sample analyzer source passes into the leaf chamber mixing volume and is twice reflected 90° by gold mirrors. The mirrors are gold plated to enhance IR reflection and provide long term stability.

After being reflected through the leaf chamber mixing volume where IR absorption occurs, infrared radiation passes through a chopping filter wheel and into the sample analyzer detector.

The chopping filter wheel has four filters that pass light in absorption and optical reference wavelengths for CO₂ and H₂O. These filters provide excellent rejection of IR radiation outside the wavelengths of interest, eliminating the effects of other IR absorbing gases.

Photosynthesis, Fluorescence, Respiration

The reference analyzer measures incoming gas concentrations and is located directly below the sample analyzer. The sample and reference analyzers can be matched at any time, either manually or automatically, without altering conditions in the leaf chamber.

The sample analyzer detector, reference analyzer detector, and chopping filter wheel are sealed in a housing that is continuously purged of CO₂ and water vapor to prevent interference.

Through years of experience the LI-6400 analyzer and sensor head have been proven to be robust and reliable, even in the most rigorous field conditions.

Battery Operation

The LI-6400 System, including optional accessories like the LED light source, are powered by 12VDC batteries stored in the console. Four batteries and a battery charger are included with the system, providing 4-8 hours of operation. The optional 6400-70 AC Adapter fits in the battery compartment.

Spare Input and Output Channels

User-programmable analog and digital I/O channels are available to support external sensors. Input channels include five differential analog, two digital, and one pulse counting. Digital outputs: 8 open drain. Analog outputs: 7 D/A 8-bit, 1 D/A 12-bit, uncalibrated CO₂ and H₂O reference and sample analyzer outputs, +5V regulated power supply (100 ma), battery voltage (fused, 200 ma).

LI-6400 Console

The LI-6400 system console combines a data acquisition system with a high speed computer for dedicated data logging and computations. High speed analog to digital converters support fast response applications.

The backlit 8 × 40 character graphical display allows any 12 experimental variables to be displayed at once. All computed variables are calculated and displayed in real time. The 66 key ASCII keyboard is membrane sealed and designed to be used under harsh field conditions.

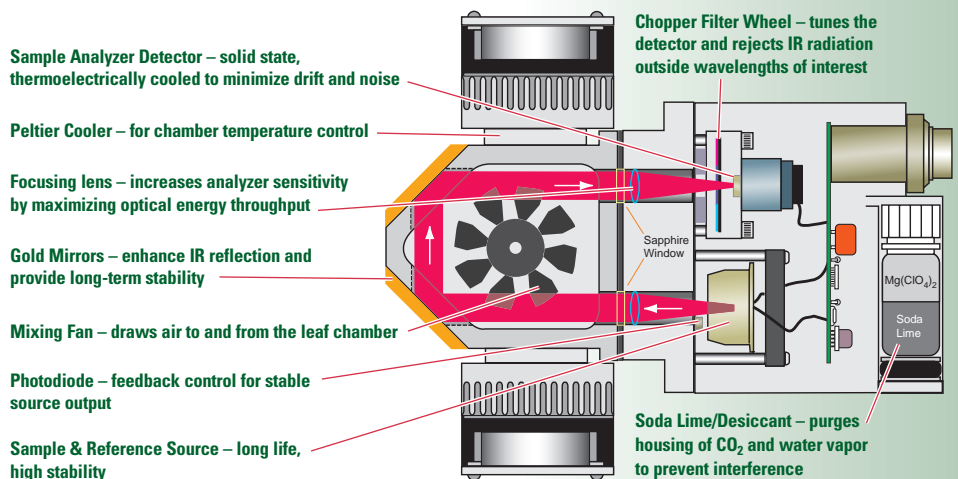
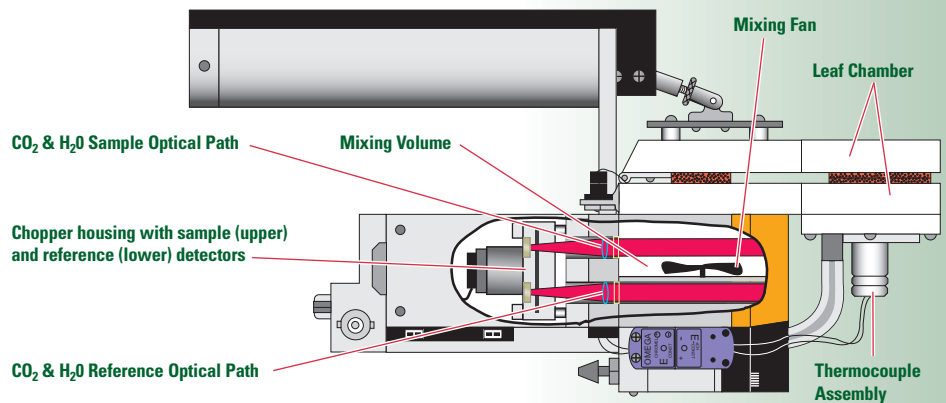

Controlling the Environment



The LI-6400 open system design allows automatic, independent control of leaf chamber CO₂, H₂O, temperature, and light.

CO₂ Control

The 6400-01 CO₂ Injector System consists of an electronic controller, a CO₂ Source Assembly that uses mini-cartridges for portable operation, and a CO₂ tank fitting for greenhouse or laboratory operation. All parts integrate directly into the

standard console with no external batteries or control modules.

The CO₂ Injector System provides a constant CO₂ input from 50 to 2000 μmol mol⁻¹. CO₂ is controlled by delivering a precisely controlled pure CO₂ stream into air that is CO₂-free. The rate of pure CO₂ injection is varied according to demand from the leaf chamber, or from the input CO₂ set point, whichever approach you specify.

The 6400-01 facilitates measurements at elevated CO₂ concentrations and the easy generation of A-Ci curves. The CO₂

injector is under complete software control, allowing you to manually set CO₂ levels from the console, or use AutoPrograms to make measurements at a series of concentrations.

The CO₂ Source Assembly is designed with robust materials for safe operation. 12g cartridges provide up to 8 hours of operation in the

field. The mini-cartridges are accessible outside the instrument, making them easy to change.

H₂O Control

The LI-6400 controls chamber humidity by automatically varying the flow rate to null-balance at the chamber humidity level you specify in software; the input flow rate can also be held constant. Flow rate is controlled by pump speed in the standard system. With the 6400-01 CO₂ Injector System (optional), pump speed is constant and flow rate to the chamber is controlled by redirecting excess flow. This “shunt regulation” allows flow to be controlled smoothly and quickly across a broad range.

Whether the controller in the 6400-01 is used or not, the air supplied to the chamber may be dry or moist. Supplying the chamber with moist air allows higher flow rates to be used to balance low transpiration rates, which provides more stable control and more accurate measurements. Inaccuracies and time delays due to water sorption on the air lines between the console and the sensor head are eliminated by measuring the reference and sample water vapor concentrations in the sensor head.

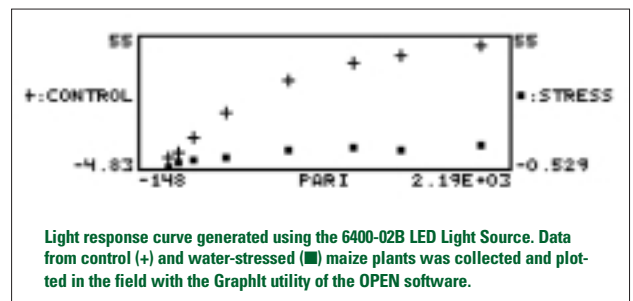

Photosynthesis, Fluorescence, Respiration

Temperature Control

Integrated Peltier coolers control temperature based on either leaf temperature or chamber block temperature (software selectable). Chamber block temperature can be set to any value within $\pm 6\text{ }^{\circ}\text{C}$ of ambient temperature. Temperature control is a standard feature of the LI-6400; no external power supplies or accessories are required.

Light Control

The 6400-02B LED Light Source or 6400-40 Leaf Chamber Fluorometer are totally integrated with the hardware and software of the LI-6400 System.

The use of LEDs with low power consumption makes them a practical light source because of their small size and ability to operate from the LI-6400's battery. LEDs also minimize the influence of the light source on the leaf temperature and are easily computer controlled.

Light source red LEDs are used to provide radiant output at 665 nm (nominal),

while blue LEDs provide output at 470 nm. The output of the blue LEDs is crucial for studying stomatal kinetics.

The Light Source and Fluorometer are continuously variable over their entire measurement ranges, so you can specify any light level without needing to make adjustments or change filters. Light levels are automatically cycled through user-entered set points when using the "Light Curve" AutoProgram, making light curve generation automatic and unattended.

The LED Light Source is easily installed, since it replaces the upper half of the standard LI-6400 leaf chamber. Having the light source as part of the leaf chamber ensures that the geometry between the leaf sample and the light source will be the same for every measurement. Careful placement of the LEDs also ensures uniform light distribution at the leaf surface.

Accuracy during operation is assured by feedback control that adjusts the light source to maintain the target value.



The 6400-02B Red/Blue LED Light Source.

Ambient Light Measurement

When using the standard leaf chamber, PAR is measured in the chamber near the leaf plane using a miniature GaAsP sensor. The external ambient Photosynthetically Active Radiation (PAR) can be measured with an optional LI-COR quantum sensor located outside the chamber.

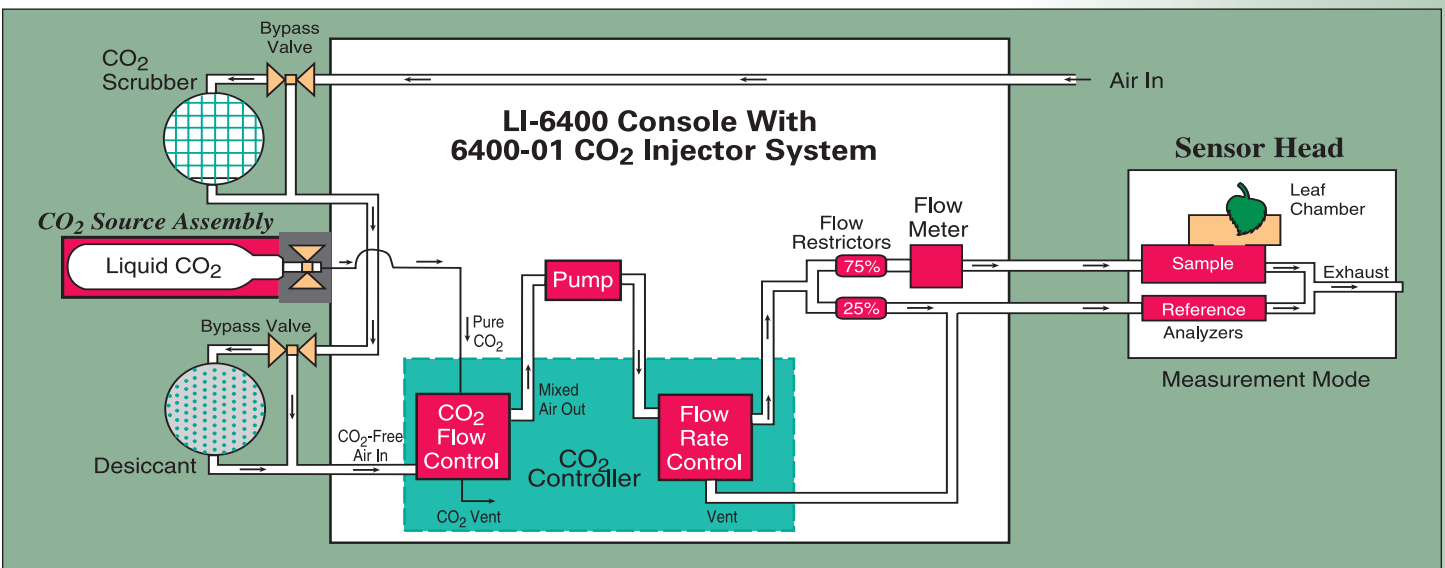

Simple, Flexible Software

Changes menu levels

Quickly scrolls through display groups (of 3 lines)

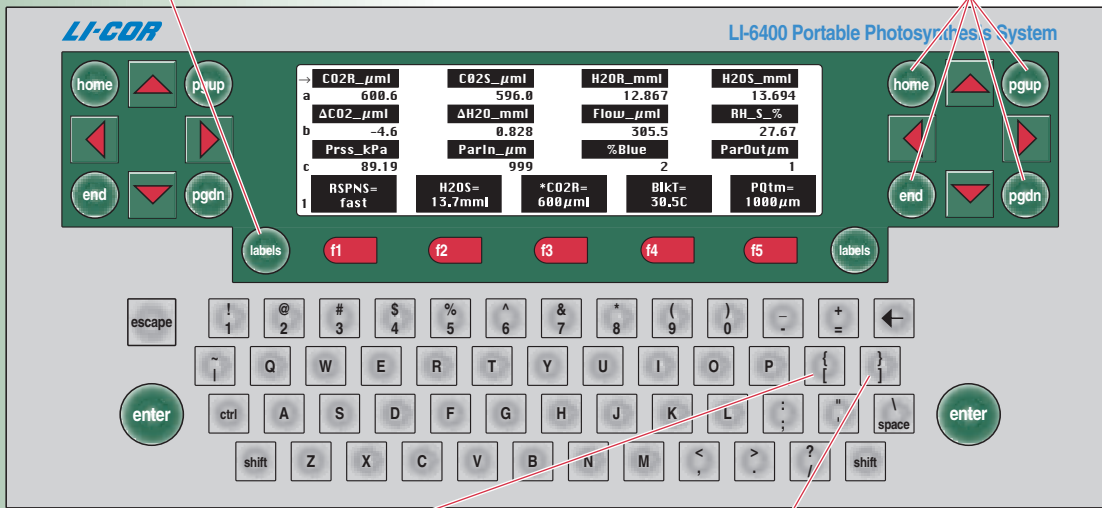

Diagnostics Mode toggle

Graphics Mode toggle

(R) Stability	Status= 3/3
(1)DCO2	(2)DH2O (3)COND
Sec	20 20 20
Mn	4.6 0.65 0.02323
SDv	2.8E-01 1.3E-01 7.1E-03
%Cl	1.9E-01 8.4E-01 2.6E-02
Slp	2.0E-03 3.3E-03 4.2E-03

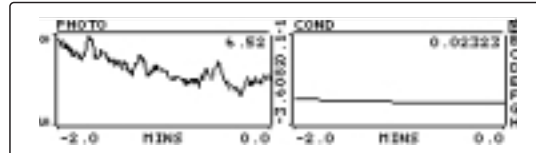

Line selector

Text Mode

12 numerical values may be displayed at once and 12 or more display lines may be changed and defined by the user

Current menu level

→	CO2R_µml	CO2_µml	H2OR_mml	H2OS_mml
a	600.6	596.0	12.867	13.694
	ΔCO2_µml	ΔH2O_mml	Flow_µml	RH_ %
b	-4.6	0.828	305.5	27.67
	Prss_kPa	ParIn_µm	%Blue	ParOut_µm
c	89.19	999	2	1
1	RSPNS= fast	H2OS= 13.7mml	*CO2R= 600µml	BlkT= 30.5C
				PQtm= 1000µm

Function keys

The LI-6400's console is a data logging computer. Measurements are performed by an application called OPEN. Other applications are stored in the file system and can be run at any time, just as computers can run different programs such as word processors and spreadsheets.

Viewing Data in the Field

OPEN uses the console's backlit 8 × 40 character graphical display to show any

12 experimental variables at once, on three user-defined lines. The display is quickly changed by moving a cursor to the line you wish to change and pressing a letter key corresponding to a display set or using the left and right arrows to scroll through all of the variables.

Real-time graphics allow you to carefully examine the approach to steady state for up to 24 variables with 3 plots per graph set. This avoids the difficulty in determining whether steady state has been

achieved when viewing in text mode. Measured or computed variables can be used in plots or strip charts. Up to 8 sets of plots can be defined and stored.

Data Logging

Any or all of the default 13 computed and 55 measured variables may be logged manually by pressing a button on the sensor head or keypad. Data can be logged to non-volatile flash memory, or output to the RS-232 port. Data can be logged manually or automatically using an AutoProgram.

For example, if you wanted to automatically collect A-Ci data, you would first set the desired chamber environmental conditions for temperature, humidity, light (if using the 6400-02B or 6400-40) and starting CO₂. Once the leaf is acclimated to these conditions, start the A-Ci Curve AutoProgram. This AutoProgram prompts (see below) for the CO₂ concentrations at which measurements

```
A-Ci Curve
Desired Ca values (µmol/mol)
400 300 200 100 50 400 400 600
Minimum wait time (secs) 60
Maximum wait time (secs) 300
```

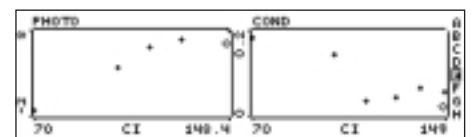

Photosynthesis, Fluorescence, Respiration

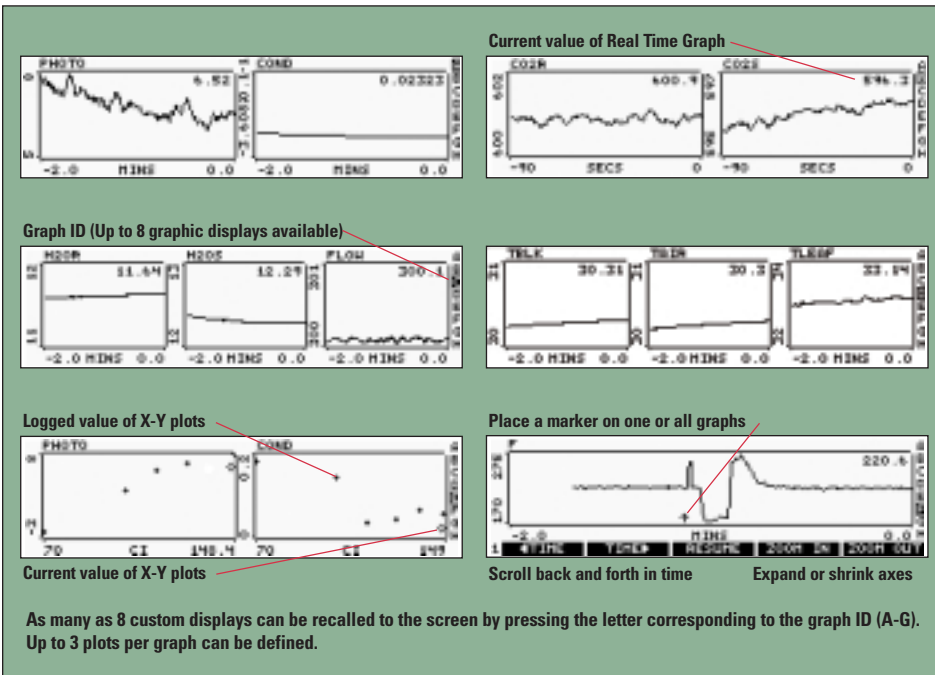

Software updates are always free and can be downloaded via the RS-232 port to your LI-6400. This makes the continued software development straightforward and guarantees that your LI-6400 will stay current.

Simulator and Control Software

With the LI-6400 simulator and control software, you can completely simulate your LI-6400 on Windows® or Macintosh® computers. It serves as an excellent training aid and data management tool, and is a convenient way to write and test your own equations or AutoPrograms.

will be logged, the minimum and maximum time between measurements, and the stability parameter(s) that must be achieved before each measurement is automatically logged. These parameters can be standard deviation, coefficient of variation, and/or slope of any set of variables. From then on, it's all automatic: for each of the specified set points, the leaf chamber is brought to that concentration. After the minimum wait time has elapsed, the system starts checking for stability. Once that occurs (or the maximum time elapses), the data are logged, and the cycle repeats for the next set point. All the while, the other environmental controls are maintaining their set points, providing stable conditions for your experiment.

Flexible Software

Virtually any type of calculation may be done with each measurement. In addition to standard gas exchange parameters, equations are included for computing leaf surface humidity, leaf surface CO₂ mole fraction, Ball-Berry Index and others.

Equations are stored in a simple list that is easy to edit.

Programs and data are stored in readable ASCII format. Using the on-board editor, you can open an existing list of computations, for example, modify it to suit your needs, and then save it under a new name.

The software can also act as a terminal to remotely control the LI-6400 and to display measurement variables on your computer. This software flexibility is not available with any other photosynthesis system, and is an invaluable tool for classroom and seminar presentations.

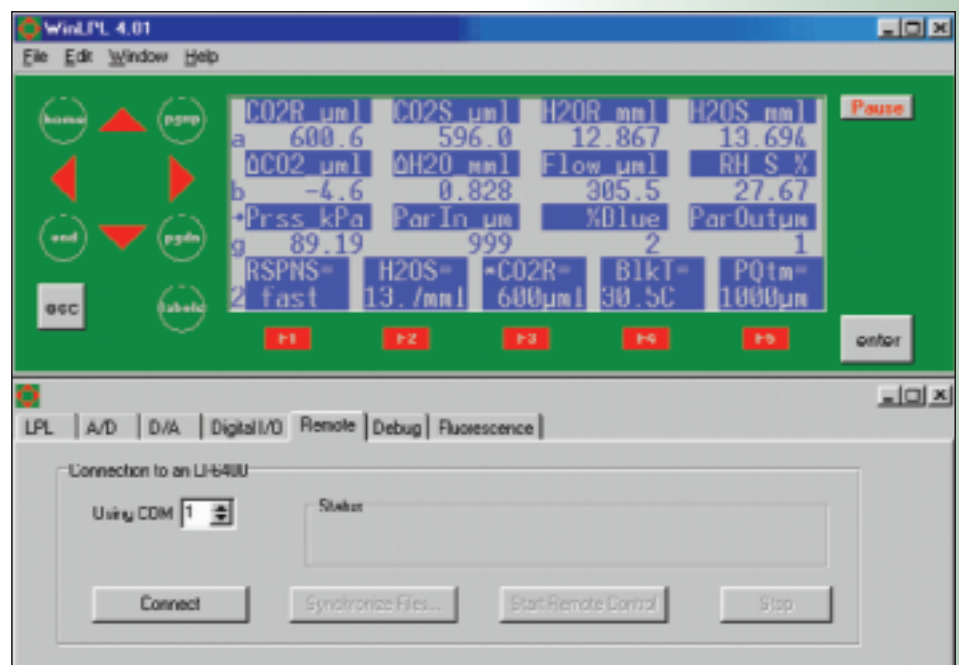

LI-6400 Simulator Software Screen.

Integrated Fluorescence Measurements



The 6400-40 Leaf Chamber Fluorometer transforms the LI-6400 System into the most integrated and powerful Portable Fluorescence and Gas Exchange System available.

- Field-installable, the fluorometer easily and quickly attaches to the LI-6400 sensor head.
- Simultaneous measurement of gas exchange and fluorescence over the same leaf area.
- Complete control of the leaf environment for collection of gas exchange and fluorescence data from a single, portable unit.
- User-defined manual or automatic measurement protocols.

Photosynthesis, Fluorescence, Respiration

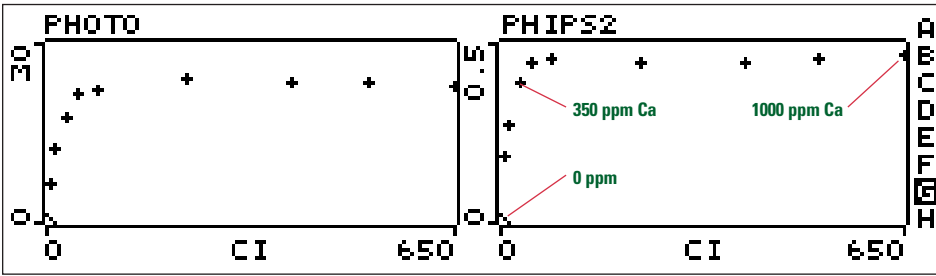

Actual console display showing combination A-Ci and Fluorescence curves.

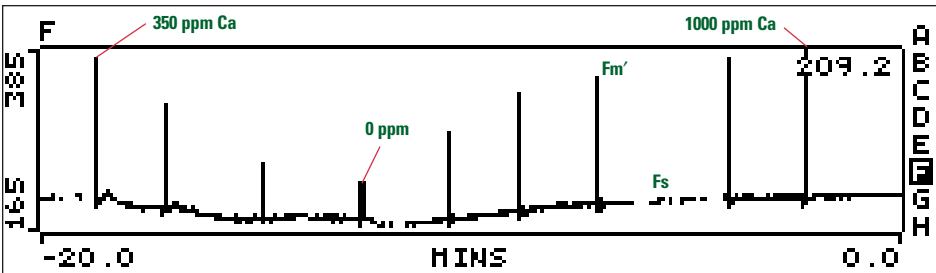

Actual console display showing Fluorescence trace of the A-Ci curve above, starting at 350 ppm, to zero, and back to 1000 ppm.



Technologically Advanced

The Leaf Chamber Fluorometer is a pulse-amplitude modulated (PAM) fluorometer that can be used to take measurements on both dark- and light-adapted samples.

Measured parameters include F_0 , F_m , F , F_m' , and F_o' , and calculated parameters include F_v , F_v/F_m , $\Delta F/F_m'$, qP , qN , NPQ , and ETR .

The 6400-40 provides complete control over the actinic and saturation (independently controlled red 630 nm and blue 470 nm LEDs), measuring (red 630 nm LEDs, modulated from 0.25 to 20 kHz), and far-red (740 nm LED for PSI excitation) light.

The unique design of the 6400-40 Leaf Chamber Fluorometer eliminates the need for fragile, awkward fiber optic light guides.

Lightweight design and low power consumption make it possible for one

person to gather data quickly and easily. Calibration information for the Leaf Chamber Fluorometer is stored onboard, making it easy to move between different LI-6400 consoles.

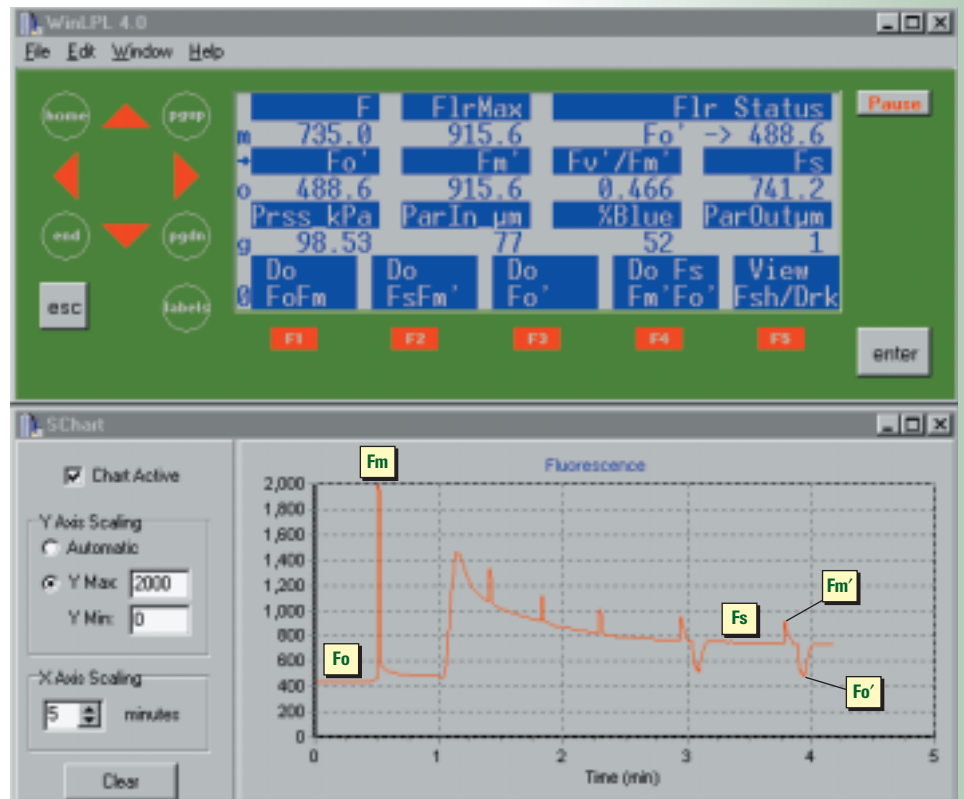

Making Soil CO₂ Flux Measurements

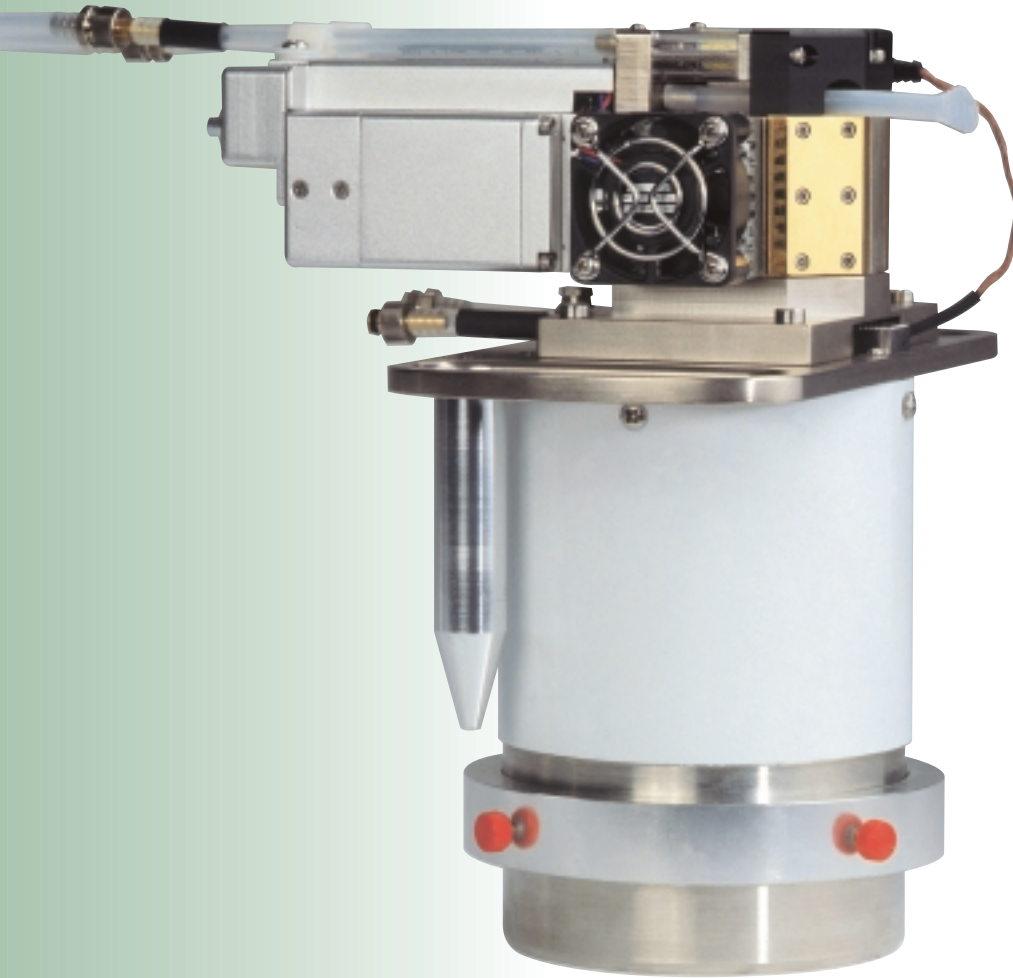

Analyzers in the Sensor Head

The 6400-09, in conjunction with the LI-6400, provides maximum operational convenience and addresses the important difficulties for soil CO₂ flux measurements. The key to the 6400-09 chamber design is having the infrared gas analyzers in the LI-6400 sensor head. Having CO₂ and H₂O analyzers right on the soil chamber makes an ideal system:

- No time delays and pressure gradients from an elaborate plumbing system.
- Air is thoroughly mixed inside the chamber while minimizing pressure gradients.
- Water vapor dilution correction results in consistently accurate data.
- Automatic scrub to just below an ambient target maintains the CO₂ gradient to within a few ppm of the natural, undisturbed value.

Easy Software Setup

Four parameters are entered from the LI-6400 keypad to control the automatic measurement:

- 1) Ambient CO₂ concentration.
- 2) The CO₂ change that determines the upper and lower set points.
- 3) Depth of the chamber in the soil (or above the soil, if using collars).
- 4) Number of measurement cycles.

Automated Cycling Protocol

At the beginning of a measurement, the LI-6400 scrubs CO₂ from the chamber air to draw the CO₂ concentration below ambient and down to the lower CO₂ concentration set point.

Drawdown Mode

In drawdown mode, air is pumped through the soda lime CO₂ scrub and back into the chamber. The system software automatically shuts the pump off and enters measurement mode once

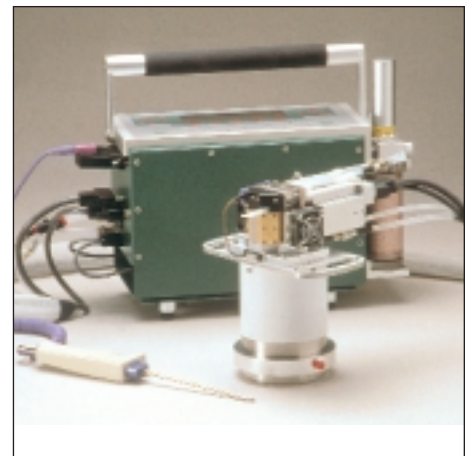

Photosynthesis, Fluorescence, Respiration

the CO₂ concentration drops below the lower set point.

Measurement Mode

The CO₂ concentration of the chamber air rises from the lower set point, passing through the target ambient CO₂ concentration, to the upper set point. Every two to three seconds, a flux is computed based on a running average of the rate of change of CO₂ concentration with time.

Flux Calculations

Following each measurement mode, the intermediate flux data are fit with a regression, which is then used to compute the soil CO₂ flux for the target ambient CO₂ concentration. Cycling now continues without operator intervention until the number of cycles specified in software are completed. This protocol results in accurate and repeatable soil CO₂ flux measurements.

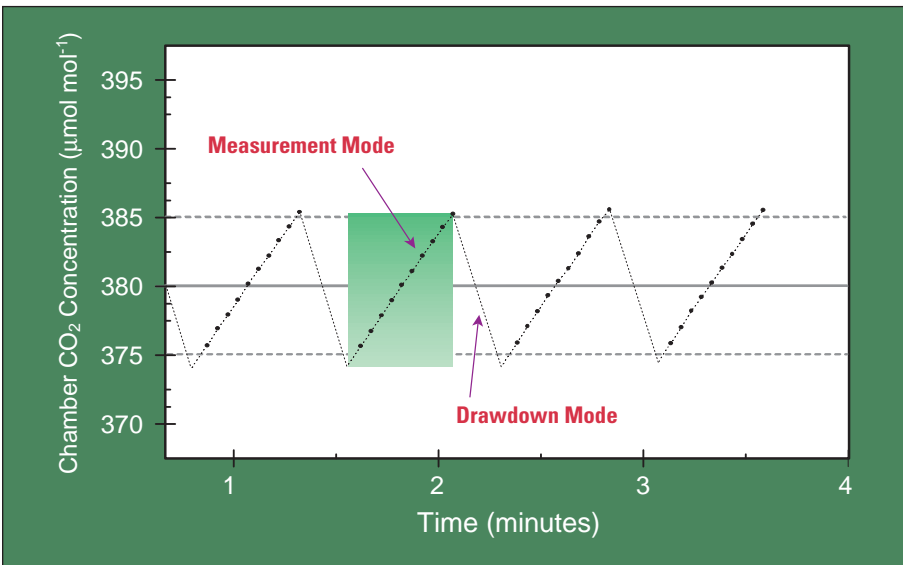

Data from a measurement with four cycles.

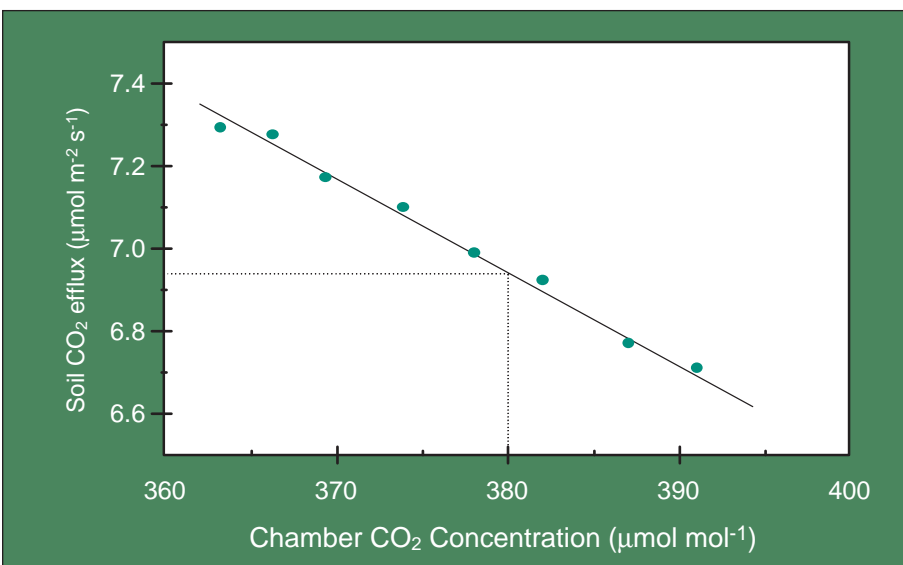

A plot of typical intermediate flux values. These intermediate values are used to calculate efflux at ambient conditions (380 μmol mol⁻¹ in this example).

Support and Training



A dedicated web support site, highly trained applications scientists and support personnel, hands-on training classes, and free software updates for the life of the instrument are just a few of the things that ensure your choice of the LI-6400 remains a smart choice for many years.

Chambers and Accessories

LI-COR's chambers are carefully constructed for ultimate ease of use and minimal environmental disturbance. Internal surfaces are nickel plated to minimize water sorption, and external surfaces are either bright anodized aluminum or covered with titanium dioxide white epoxy to minimize radiation absorbance and maximize emissivity.

The chamber gaskets have minimal interaction with CO₂ and water vapor, seal tightly, and do not exhibit a permanent memory where leaf midribs and other structures press into the gaskets when the chamber is sealed.

In the 6400-05, -07, -08, and -15 leaf chambers, the leaf temperature is estimated from energy balance. In all other chambers, leaf temperature is measured using a leaf temperature thermocouple.



Standard 2 × 3 cm Chamber

6400-05 Conifer Chamber



The conifer chamber is constructed of acrylic for durability and lined with teflon to minimize water sorption. Shoots with needles up to 3.5 cm long can be accommodated in the 7.5 cm diameter chamber. The 6400-05 mounts directly to the sample cell of the LI-6400's CO₂ and H₂O IRGAs.

6400-07 Needle Chamber



Photosynthesis rates of long needled conifers are easily measured using the

6400-07 Needle Chamber. The 6400-07 has a 2 × 6 cm aperture and specially designed foam mounting pads that hold up to five needles in the chamber. The 6400-07 allows each needle to be pressed into place in the chamber, where it is held securely in the channels of the foam mounting pad.

The chamber top and bottom have replaceable clear Propafilm® windows for excellent light transmittance. A quantum sensor in the chamber provides light measurement at the plane of the needles.

6400-08 Clear Chamber Bottom

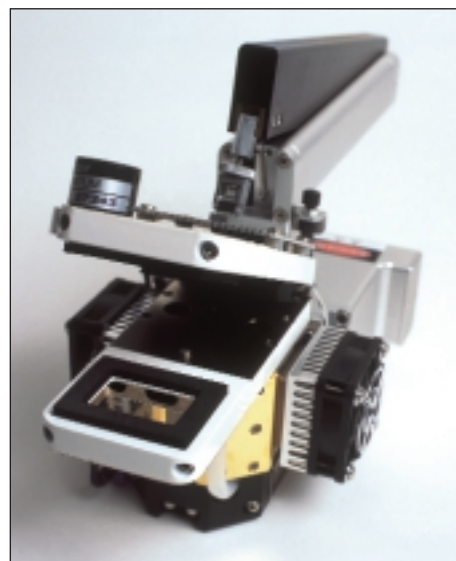

Illuminating the bottom of a leaf is particularly useful for survey measurements and erect foliage. The Clear Chamber Bottom has a Propafilm® window similar to the standard chamber top. The Clear Chamber Bottom is designed to be used with any 2 × 3 cm chamber top.

Photosynthesis, Fluorescence, Respiration

6400-11 Narrow Leaf Chamber



The 6400-11 Narrow Leaf Chamber is ideal for foliage with narrow bladed leaves. The 6400-11 has a 2×6 cm aperture and uses the same chamber top as the Needle Chamber. A quantum sensor for light measurement at the leaf plane is included.

6400-15 Arabidopsis Chamber

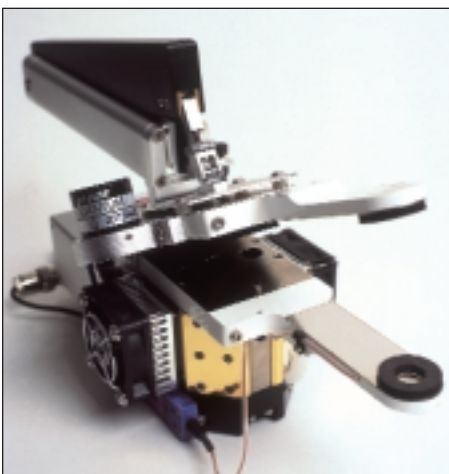

The 6400-15 Arabidopsis Chamber was designed for measurement of small leaves

such as Arabidopsis, which are difficult to clamp with conventional chambers.

This chamber has clear apertures for natural illumination of the top and bottom of the leaf. The aperture is 1.0 cm in diameter and is positioned 8.5 cm away from the main body of the IRGA.

This design allows you to access and measure small leaves that are tightly bunched together.

6400-19 Custom Chamber Kit



Contains the sample optical path mounting plate and accessories commonly used to make custom chambers for the LI-6400, like the one shown above.

9964-053 Sample Cell Outlet Manifold

The 9964-053 Sample Cell Outlet Manifold replaces the standard LI-6400 bottom chamber. The manifold's purpose is to isolate the gas analyzer sample cell from the leaf chamber so the LI-6400 can be used as a stand-alone gas analyzer.

Fluorescence Adapter Chambers

Adapters to accommodate fiber probe sizes of 2 mm (6400-10), 8 mm (6400-06), and 10 mm (6400-14) are available. Each chamber has a quantum sensor that allows incident irradiance to be measured.

The clear chamber windows are lined with teflon to minimize water sorption, and can be used with either the standard 2×3 chamber bottom, or the 6400-08 Clear Chamber Bottom. The probe is mounted 60° from the leaf plane in all cases.

Ordering

LI-6400 Portable Photosynthesis System
Includes system console with 128MB RAM for operation and 64 MB flash memory for system software and data storage; sensor head with CO₂/H₂O analyzers; standard 6 cm² leaf chamber with internal PAR sensor; four 6400-03 Rechargeable Batteries with battery charger; 9-pin to 9-pin RS-232 cable and adapter; CD with software for Windows® and Macintosh®; spares kit; carrying case.

Additional Accessories



LI-610 Portable Dew Point Generator



6400-70 AC Adapter

LI-6400 Specifications*

CO₂ Analyzer

Type: Absolute, open path, non-dispersive infrared gas analyzer.

Range: 0-3000 $\mu\text{mol mol}^{-1}$.

Bandwidth: 10 Hz.

Signal Noise: Typically 0.3 $\mu\text{mol mol}^{-1}$ peak-to-peak at 350 $\mu\text{mol mol}^{-1}$ with 1 second signal averaging; 0.8 $\mu\text{mol mol}^{-1}$ maximum. With 4 second signal averaging, signal noise is typically 0.2 $\mu\text{mol mol}^{-1}$ peak-to-peak.

Accuracy: Maximum deviation: $\pm 5 \mu\text{mol mol}^{-1}$ from 0 to 1500 $\mu\text{mol mol}^{-1}$ $\pm 10 \mu\text{mol mol}^{-1}$ from 1500 to 3000 $\mu\text{mol mol}^{-1}$.

Sensor: Solid state. Minimal sensitivity to motion.

Orientation Sensitivity: $\leq \pm 1 \mu\text{mol mol}^{-1}$ at 350 $\mu\text{mol mol}^{-1}$ from any orientation.

H₂O Analyzer

Type: Absolute, open path, non-dispersive infrared gas analyzer.

Range: 0-75 mmol mol⁻¹, or 40°C dew point.

Bandwidth: 10 Hz.

Signal Noise: Typically 0.04 mmol mol⁻¹ peak-to-peak at 20 mmol mol⁻¹ with 1 second signal averaging; 0.06 mmol mol⁻¹ maximum. With 4 second signal averaging, signal noise is typically 0.03 mmol mol⁻¹ peak-to-peak.

Accuracy: Maximum deviation: $\pm 1.0 \text{ mmol mol}^{-1}$ from 0-75 mmol mol⁻¹.

Temperature

Operating Temperature Range: 0°C to 50°C.

Optical Housing Block and Air Temperature:

Sensor Type: 3-wire thermistor.

Range: -10 to 50°C.

Accuracy: Maximum error $\leq \pm 0.5^\circ\text{C}$.

Typical Error: $\leq \pm 0.25^\circ\text{C}$.

Temperature Control: Leaf chamber can be heated or cooled $\pm 6^\circ\text{C}$ from ambient.

Control Range: 0 to 50.0°C.

Set point Resolution: 0.2°C.

Leaf Temperature Thermocouple:

Type: E.

Range: $\pm 50^\circ\text{C}$ of reference.

Reference: Optical housing block thermistor.

Accuracy: $\pm 10\%$ of T difference between sample and reference junctions with amplifier zeroed; typically $< 0.2^\circ\text{C}$.

Air Flow

Flow rate: 0 to 700 $\mu\text{mol s}^{-1}$ with 6400-01 CO₂ injector and 150 to 1000 $\mu\text{mol s}^{-1}$ without CO₂ injector.

Pressure

Pressure Range: 65 to 110 kPa absolute.

Accuracy: $\pm 0.1\%$ of full scale.

Resolution: 0.002 kPa.

Signal Noise (peak-to-peak): 0.002 kPa typical.

System Console

Memory: 128 MB RAM for operation; 64 MB flash memory for data storage.

Display: Adjustable contrast, backlit, 8 line \times 40 character (240 \times 64 dot) LCD graphic display.

Keyboard: Full ASCII keypad, sealed from dust and moisture with membrane overlay.

Power Requirement: 10.5 to 15 VDC; 4A maximum (current draw dependent upon system operation). $< 10\text{A}$ momentary peak.

Output

Signal: RS-232 hardwired DTE.

Format: User-definable ASCII.

6400-01 CO₂ Injector

CO₂ Mixing Range: $< 50 \mu\text{mol mol}^{-1}$ to $> 2000 \mu\text{mol mol}^{-1}$.

Operating Temperature Range: 0-50°C.

CO₂ Source Assembly:

Type: 12g pure liquid CO₂ cylinder.

Lifetime: 8 hours after activation regardless of use.

CO₂ Tank Connector Block:

Minimum Pressure: 1250 kPa (180 psig).

Maximum Pressure: 1500 kPa (220 psig).

Usage Rate: constant at $\approx 10 \text{ sccm}$.

Light Measurement

PAR Internal and External Chamber Sensors:

Range: 0 to $> 3000 \mu\text{mol m}^{-2} \text{ s}^{-1}$.

Resolution: $< 1 \mu\text{mol m}^{-2} \text{ s}^{-1}$.

Calibration Accuracy: $\pm 5\%$ of reading, traceable to NIST.

6400-02B LED Light Source

Output Range: 0 to 2000 $\mu\text{mol m}^{-2} \text{ s}^{-1}$ at 30°C.

Minimum Fraction Blue: 5% (photon basis).

Typical Fraction Blue: 100 $\mu\text{mol m}^{-2} \text{ s}^{-1}$, 13%, 1000 $\mu\text{mol m}^{-2} \text{ s}^{-1}$, 10%, 2000 $\mu\text{mol m}^{-2} \text{ s}^{-1}$, 7%.

Red Peak Wavelength: 665 nm $\pm 10 \text{ nm}$ at 25°C.

Blue Peak Wavelength: 470 nm $\pm 10 \text{ nm}$ at 25°C.

Power Consumption at 2000 $\mu\text{mol m}^{-2} \text{ s}^{-1}$: 8W.

Operating Temperature Range: 0-50°C.

Size: 5.2H \times 5.6W \times 7.3D cm (2.0 \times 2.2 \times 2.9 in.).

Weight: 0.2 kg (0.44 lb.).

*Specifications subject to change without notice.

Special Pricing Packages

LI-6400R

Includes LI-6400 Portable Photosynthesis System, 6400-40 Leaf Chamber Fluorometer, 6400-01 CO₂ Injector System, 6400-02B Red/Blue LED Light Source, and 9901-013 External Quantum Sensor.

LI-6400F

Includes LI-6400 Portable Photosynthesis System, 6400-40 Leaf Chamber Fluorometer, 6400-01 CO₂ Injector System, and 9901-013 External Quantum Sensor.

LI-6400P

Includes LI-6400 Portable Photosynthesis System, 6400-01 CO₂ Injector System, 6400-02B Red/Blue LED Light Source, and 9901-013 External Quantum Sensor.

LI-6400Q

Includes LI-6400 Portable Photosynthesis System, 6400-01 CO₂ Injector System, and 9901-013 External Quantum Sensor.

LI-COR®

Biosciences

4421 Superior Street • P.O. Box 4425 • Lincoln, Nebraska 68504 USA
North America: 800-447-3576 • International: 402-467-3576 • FAX: 402-467-2819
ensales@licor.com • www.licor.com

The LI-6400 and the Leaf Chamber Fluorometer are covered by the following patents held by LI-COR:
LI-6400: US 5,340,987 and foreign equivalents US 5,457,320. Leaf Chamber Fluorometer: Patents Pending.

LI-COR is a registered trademark of LI-COR, Inc. All brand and product names are trademarks or registered trademarks of their respective owners. Copyright 2002, LI-COR Inc. Printed in the U.S.A.

980-06613, Rev. 1

The LI-COR board of directors would like to take this opportunity to return thanks to God for His merciful providence in allowing LI-COR to develop and commercialize products, through the collective effort of dedicated employees, that enable the examination of the wonders of His works.

"Trust in the LORD with all your heart and do not lean on your own understanding. In all your ways acknowledge Him, and He will make your paths straight"

—Proverbs 3:5,6